

Alle helfen Wasser tragen

Jeder füllt in seinen Kessel, so viel er will.

A bringt

B bringt

C bringt

D bringt

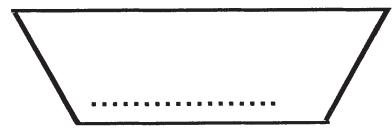
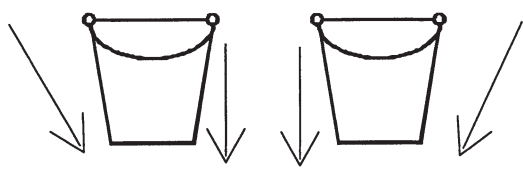
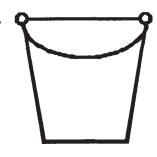
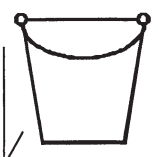
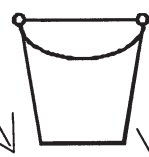
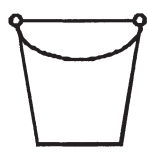

.....

E bringt

F bringt

G bringt

H bringt

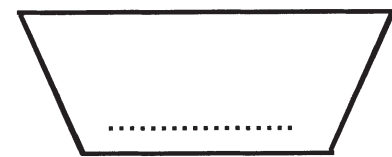
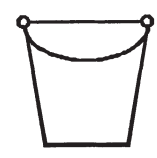
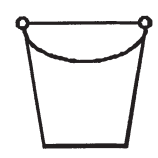
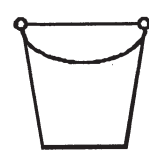
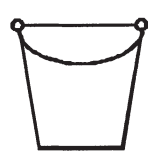

.....

I bringt

K bringt

L bringt

M bringt

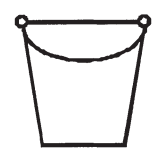
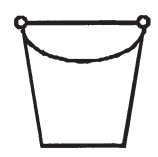
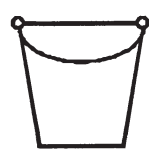

.....

N bringt

O bringt

P bringt

R bringt

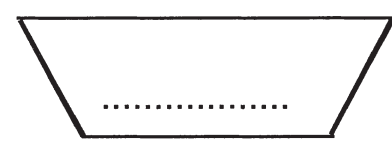
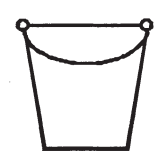
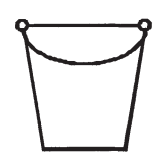
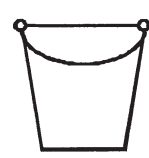
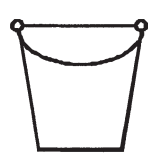

.....



Wir betrachten den Massbecher und berichten

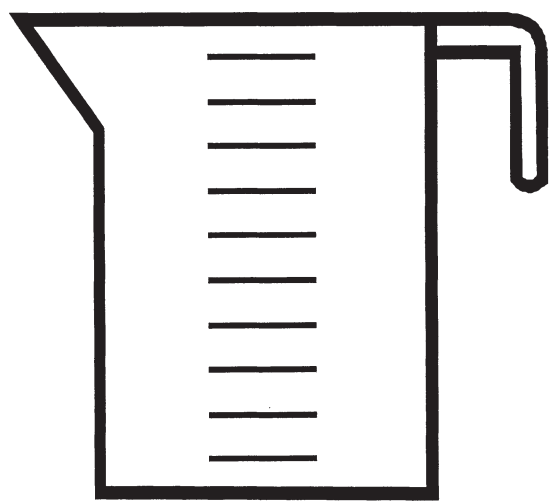

Was gibt 1 l ?

- 8 dl + dl = 1 l
- 6 dl + dl =
- 4 dl + dl =
- 5 dl + dl =
- 1 dl + dl =
- 7 dl + dl =
- 2 dl + dl =
- 9 dl + dl =
- 3 dl + dl =

- 15 dl = 1 l 5 dl
- 36 dl =
- 82 dl =
- 43 dl =

- 54 dl =
- 49 dl =
- 72 dl =
- 65 dl =

- 6 l 7 dl = dl
- 4 l 3 dl =
- 2 l 7 dl =
- 8 l 1 dl =

- 1 l 6 dl = dl
- 5 l 2 dl =
- 7 l 8 dl =
- 9 l 6 dl =

Es gibt auch halbe Liter.
Darauf steht 1/2 l

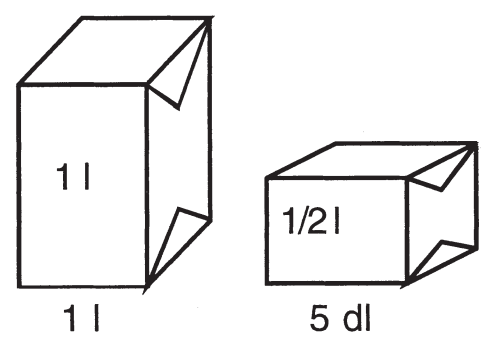

- 1/2 l Milch
- 1/2 l Rahm
- 1/2 l Orangensaft
- 1/2 l Ovomaltine
- 1/2 l Citro

Übungsblätter zum Hohlmass

Wir füllen auf 10 l auf

? ? ? ?

	6 l 5 dl
	3 l 5 dl	4 l 2 dl	6 l 4 dl	2 l 8 dl
10 l	10 l	10 l	10 l	

? ? ? ?

	5 l 1 dl	8 l 3 dl	1 l 9 dl	7 l 6 dl
10 l	10 l	10 l	10 l	

? ? ? ?

	3 l 4 dl	4 l 3 dl	3 l 3 dl	6 l 6 dl
10 l	10 l	10 l	10 l	

? ? ? ?

	8 dl	9 l 2 dl	5 l 5 dl	8 l 8 dl
10 l	10 l	10 l	10 l	

Kannst du davon Rechnungen schreiben?

Kleine Gefäße in cl beschriften

6 dl

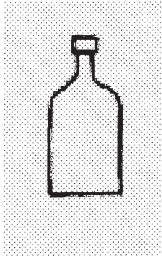

..... cl

1 dl

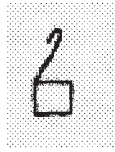

..... cl

7 dl

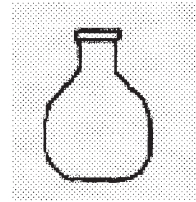

..... cl

1 l

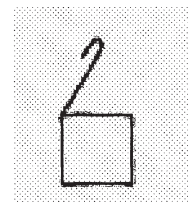

..... cl

2 dl



.....

5 dl



.....

8 dl



.....

3 dl



.....

1 l 4 dl



.....

9 dl



.....

1/2 l



.....

1 1/2 l



.....

.....



.....

.....



.....

.....



.....

.....



.....